

PN2907A

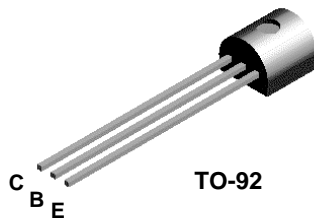

MMBT2907A

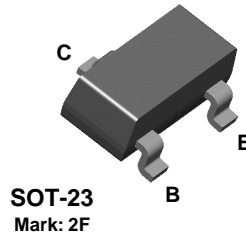

PZT2907A

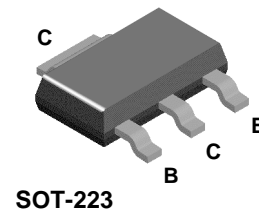

PNP General Purpose Amplifier

This device is designed for use as a general purpose amplifier and switch requiring collector currents to 500 mA. Sourced from Process 63.

Absolute Maximum Ratings*

$T_A = 25^\circ\text{C}$ unless otherwise noted

Symbol	Parameter	Value	Units
V_{CEO}	Collector-Emitter Voltage	60	V
V_{CBO}	Collector-Base Voltage	60	V
V_{EBO}	Emitter-Base Voltage	5.0	V
I_C	Collector Current - Continuous	800	mA
T_J, T_{stg}	Operating and Storage Junction Temperature Range	-55 to +150	$^\circ\text{C}$

*These ratings are limiting values above which the serviceability of any semiconductor device may be impaired.

NOTES:

- 1) These ratings are based on a maximum junction temperature of 150 degrees C.
- 2) These are steady state limits. The factory should be consulted on applications involving pulsed or low duty cycle operations.
- 3) All voltages (V) and currents (A) are negative polarity for PNP transistors.

Thermal Characteristics

$T_A = 25^\circ\text{C}$ unless otherwise noted

Symbol	Characteristic	Max			Units
		PN2907A	*MMBT2907A	**PZT2907A	
P_D	Total Device Dissipation	625	350	1,000	mW
	Derate above 25°C	5.0	2.8	8.0	mW/ $^\circ\text{C}$
$R_{\theta JC}$	Thermal Resistance, Junction to Case	83.3			$^\circ\text{C}/\text{W}$
$R_{\theta JA}$	Thermal Resistance, Junction to Ambient	200	357	125	$^\circ\text{C}/\text{W}$

* Device mounted on FR-4 PCB 1.6" X 1.6" X 0.06."

** Device mounted on FR-4 PCB 36 mm X 18 mm X 1.5 mm; mounting pad for the collector lead min. 6 cm².

PNP General Purpose Amplifier

(continued)

Electrical Characteristics

$T_A = 25^\circ\text{C}$ unless otherwise noted

Symbol	Parameter	Test Conditions	Min	Max	Units
OFF CHARACTERISTICS					
$V_{(BR)CEO}$	Collector-Emitter Breakdown Voltage*	$I_C = 10\text{ mA}, I_B = 0$	60		V
$V_{(BR)CBO}$	Collector-Base Breakdown Voltage	$I_C = 10\text{ }\mu\text{A}, I_E = 0$	60		V
$V_{(BR)EBO}$	Emitter-Base Breakdown Voltage	$I_E = 10\text{ }\mu\text{A}, I_C = 0$	5.0		V
I_B	Base Cutoff Current	$V_{CB} = 30\text{ V}, V_{EB} = 0.5\text{ V}$		50	nA
I_{CEX}	Collector Cutoff Current	$V_{CE} = 30\text{ V}, V_{BE} = 0.5\text{ V}$		50	nA
I_{CBO}	Collector Cutoff Current	$V_{CB} = 50\text{ V}, I_E = 0$ $V_{CB} = 50\text{ V}, I_E = 0, T_A = 150^\circ\text{C}$		0.02 20	μA μA

ON CHARACTERISTICS

h_{FE}	DC Current Gain	$I_C = 0.1\text{ mA}, V_{CE} = 10\text{ V}$ $I_C = 1.0\text{ mA}, V_{CE} = 10\text{ V}$ $I_C = 10\text{ mA}, V_{CE} = 10\text{ V}$ $I_C = 150\text{ mA}, V_{CE} = 10\text{ V}^*$ $I_C = 500\text{ mA}, V_{CE} = 10\text{ V}^*$	75 100 100 100 50	300	
$V_{CE(sat)}$	Collector-Emitter Saturation Voltage*	$I_C = 150\text{ mA}, I_B = 15\text{ mA}$ $I_C = 500\text{ mA}, I_B = 50\text{ mA}$		0.4 1.6	V V
$V_{BE(sat)}$	Base-Emitter Saturation Voltage	$I_C = 150\text{ mA}, I_B = 15\text{ mA}^*$ $I_C = 500\text{ mA}, I_B = 50\text{ mA}$		1.3 2.6	V V

SMALL SIGNAL CHARACTERISTICS

f_T	Current Gain - Bandwidth Product	$I_C = 50\text{ mA}, V_{CE} = 20\text{ V},$ $f = 100\text{ MHz}$	200		MHz
C_{obo}	Output Capacitance	$V_{CB} = 10\text{ V}, I_E = 0,$ $f = 100\text{ kHz}$		8.0	pF
C_{ibo}	Input Capacitance	$V_{EB} = 2.0\text{ V}, I_C = 0,$ $f = 100\text{ kHz}$		30	pF

SWITCHING CHARACTERISTICS

t_{on}	Turn-on Time	$V_{CC} = 30\text{ V}, I_C = 150\text{ mA},$ $I_{B1} = 15\text{ mA}$		45	ns
t_d	Delay Time			10	ns
t_r	Rise Time			40	ns
t_{off}	Turn-off Time	$V_{CC} = 6.0\text{ V}, I_C = 150\text{ mA}$ $I_{B1} = I_{B2} = 15\text{ mA}$		100	ns
t_s	Storage Time			80	ns
t_f	Fall Time			30	ns

*Pulse Test: Pulse Width $\leq 300\text{ }\mu\text{s}$, Duty Cycle $\leq 2.0\%$

NOTE: All voltages (V) and currents (A) are negative polarity for PNP transistors.

Spice Model

PNP (Is=650.6E-18 Xti=3 Eg=1.11 Vaf=115.7 Bf=231.7 Ne=1.829 Ise=54.81f Ikf=1.079 Xtb=1.5 Br=3.563 Nc=2 Isc=0 Ikr=0 Rc=.715 Cjc=14.76p Mjc=.5383 Vjc=.75 Fc=.5 Cje=19.82p Mje=.3357 Vje=.75 Tr=111.3n Tf=603.7p Itf=.65 Vtf=5 Xtf=1.7 Rb=10)

PN2907A / MMBT2907A / PZT2907A

PNP General Purpose Amplifier
(continued)

PN2907A / MMBT2907A / PZT2907A

Typical Characteristics

Typical Pulsed Current Gain vs Collector Current

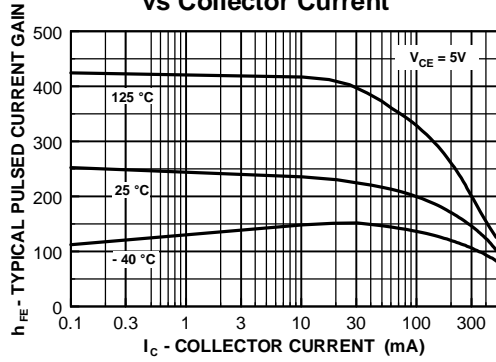

Collector-Emitter Saturation Voltage vs Collector Current

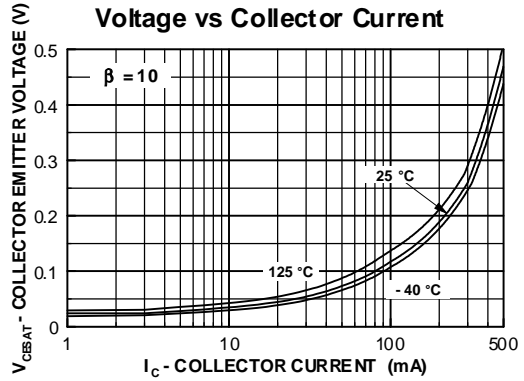

Base-Emitter Saturation Voltage vs Collector Current

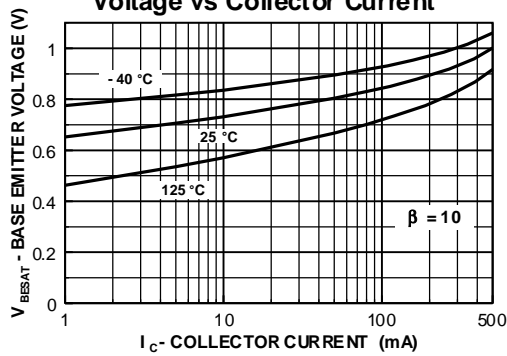

Base Emitter ON Voltage vs Collector Current

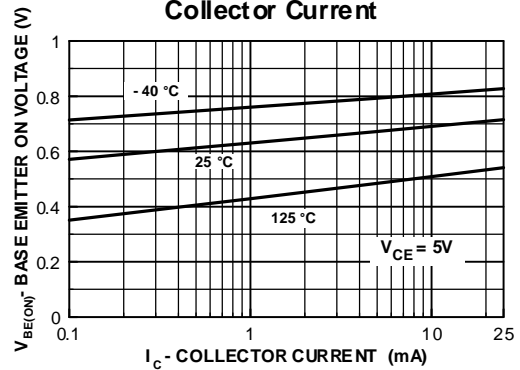

Collector-Cutoff Current vs Ambient Temperature

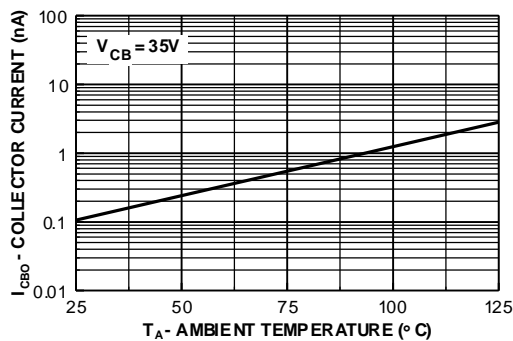

Input and Output Capacitance vs Reverse Bias Voltage

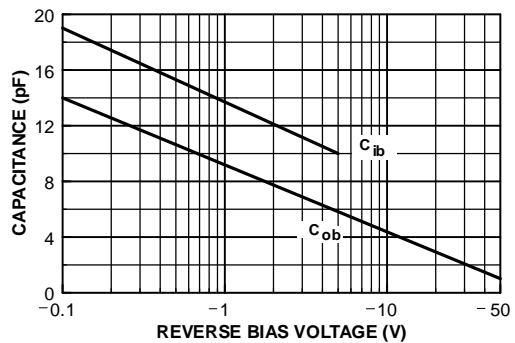

Typical Characteristics (continued)

Switching Times vs Collector Current



Turn On and Turn Off Times vs Collector Current

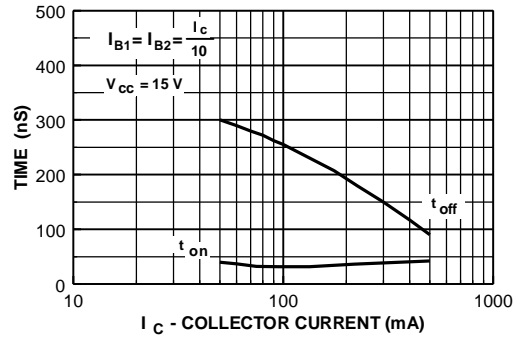

Rise Time vs Collector and Turn On Base Currents

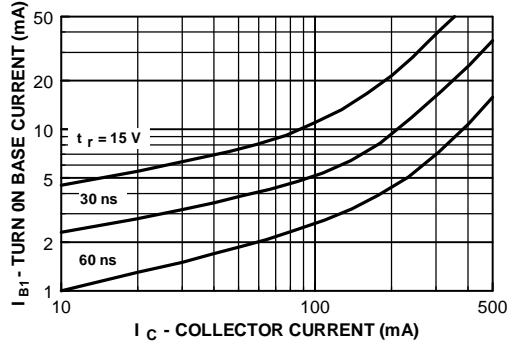

Power Dissipation vs Ambient Temperature

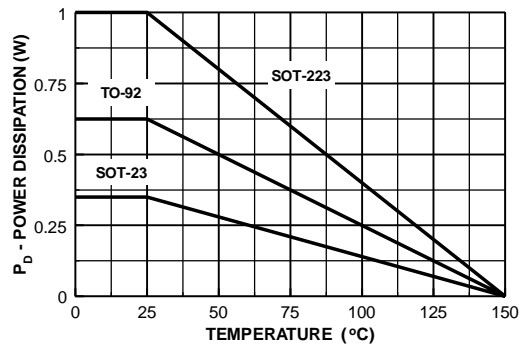

Typical Common Emitter Characteristics (f = 1.0kHz)



Test Circuits



FIGURE 1: Saturated Turn-On Switching Time Test Circuit

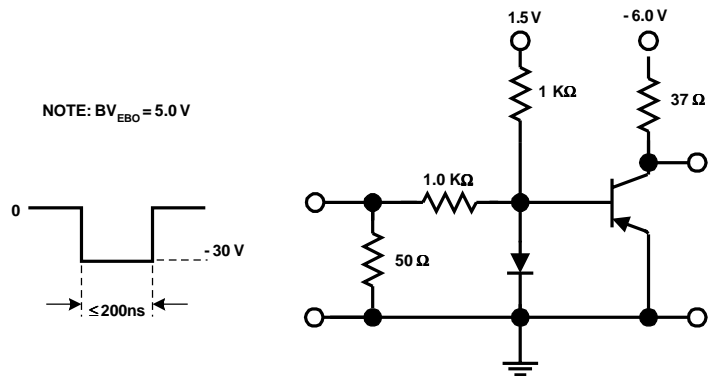

FIGURE 2: Saturated Turn-Off Switching Time Test Circuit

TRADEMARKS

The following are registered and unregistered trademarks Fairchild Semiconductor owns or is authorized to use and is not intended to be an exhaustive list of all such trademarks.

ACE ^x TM	FAST ^r TM	PowerTrench [®]	SyncFET TM
Bottomless TM	GlobalOptoisolator TM	QFET TM	TinyLogic TM
CoolFET TM	GTO TM	QS TM	UHC TM
CROSSVOLT TM	HiSeC TM	QT Optoelectronics TM	VCX TM
DO ^M E TM	ISOP ^L ANAR TM	Quiet Series TM	
E ² CMOS TM	MICROWIRE TM	SILENT SWITCHER [®]	
EnSigna TM	OPTOLOGIC TM	SMART START TM	
FACT TM	OPTOPLANAR TM	SuperSOT TM -3	
FACT Quiet Series TM	PACMAN TM	SuperSOT TM -6	
FAST [®]	POP TM	SuperSOT TM -8	

DISCLAIMER

FAIRCHILD SEMICONDUCTOR RESERVES THE RIGHT TO MAKE CHANGES WITHOUT FURTHER NOTICE TO ANY PRODUCTS HEREIN TO IMPROVE RELIABILITY, FUNCTION OR DESIGN. FAIRCHILD DOES NOT ASSUME ANY LIABILITY ARISING OUT OF THE APPLICATION OR USE OF ANY PRODUCT OR CIRCUIT DESCRIBED HEREIN; NEITHER DOES IT CONVEY ANY LICENSE UNDER ITS PATENT RIGHTS, NOR THE RIGHTS OF OTHERS.

LIFE SUPPORT POLICY

FAIRCHILD'S PRODUCTS ARE NOT AUTHORIZED FOR USE AS CRITICAL COMPONENTS IN LIFE SUPPORT DEVICES OR SYSTEMS WITHOUT THE EXPRESS WRITTEN APPROVAL OF FAIRCHILD SEMICONDUCTOR CORPORATION. As used herein:

1. Life support devices or systems are devices or systems which, (a) are intended for surgical implant into the body, or (b) support or sustain life, or (c) whose failure to perform when properly used in accordance with instructions for use provided in the labeling, can be reasonably expected to result in significant injury to the user.
2. A critical component is any component of a life support device or system whose failure to perform can be reasonably expected to cause the failure of the life support device or system, or to affect its safety or effectiveness.

PRODUCT STATUS DEFINITIONS

Definition of Terms

Datasheet Identification	Product Status	Definition
Advance Information	Formative or In Design	This datasheet contains the design specifications for product development. Specifications may change in any manner without notice.
Preliminary	First Production	This datasheet contains preliminary data, and supplementary data will be published at a later date. Fairchild Semiconductor reserves the right to make changes at any time without notice in order to improve design.
No Identification Needed	Full Production	This datasheet contains final specifications. Fairchild Semiconductor reserves the right to make changes at any time without notice in order to improve design.
Obsolete	Not In Production	This datasheet contains specifications on a product that has been discontinued by Fairchild semiconductor. The datasheet is printed for reference information only.